



# FIRESPY

4-BUS SERIES

Gen4

4432bT  
4832bT



## PRODUCT OVERVIEW:

The **FireSpy4432bT** and **FireSpy4832bT** are the world's only four-channel dedicated-Mil1394 analyzers. Based on the 4<sup>th</sup> generation FireSpy analyzer architecture the **FireSpy4x32bT** is the most advanced IEEE 1394 test equipment in the market. The **FireSpy4x30xx** in fact combines four FireSpy analyzers in one single instrument. It comprises a powerful on-board processor and improved connectivity to the host.

The **FireSpy4x3bT** has four 1394 nodes connected to two synchronized analysis engines. Both engines are controlled by a dual core ARM processor running at 667MHz. Each node is connected to two 1394 ports with LEMO connectors. The unique number of interconnecting nodes makes the **FireSpy4x32bT** ideally suited to monitor four independent IEEE 1394 buses at the same time. A typical example could be the monitoring of all 3 branches of a triple redundant network as well as the Cross-Channel Data Link (CCDL). Of course, other connection options are possible as well.

The **FireSpy4x32bT** is equipped with 10 GB internal memory and extensive hardware filtering and trigger possibilities. The analyzer can be connected to a host computer using the USB3 interface. On the host you can control the FireSpy using a graphical user interface to analyze and display the bus traffic in a user-friendly way; or you can use the API to program your own control software.

The seamless integration of the SAE AS5643 protocol (Mil1394) makes the **FireSpy4x3bT** the preferred tool for many Aerospace & Defense development tasks. DapTechnology has taken considerable efforts to fully support the SAE AS5643 protocol in all major functional areas of the **FireSpy4x32bT** and continuously updates the analyzer functionality according to implementation requirements and ongoing standardization efforts.

### Key Features

- IEEE 1394-2008 Beta
- S100B-S800B transfer rates depending on exact model
- Host connection via USB 3.0
- On-board dual core 667 MHz ARM processor and programmable logic
- 10GByte internal memory
- GUI and API for Windows™ Operating Systems
- 4 analyzing nodes with a total of 8x 1394 ports
  - Optionally, all ports are active transformer coupled
  - Optionally, all ports can provide bus power
- Powerful software provides:
  - Monitor
  - Recorder
  - Commander
  - Scriptor
  - Generator
  - Filter and Trigger
  - Support for AS5643, IEC61883, AV/C, SBP2, IP1394, AMI-C and IIDC protocols
- Internal SelfTest
- C/C++ API with wrappers for LabVIEW™

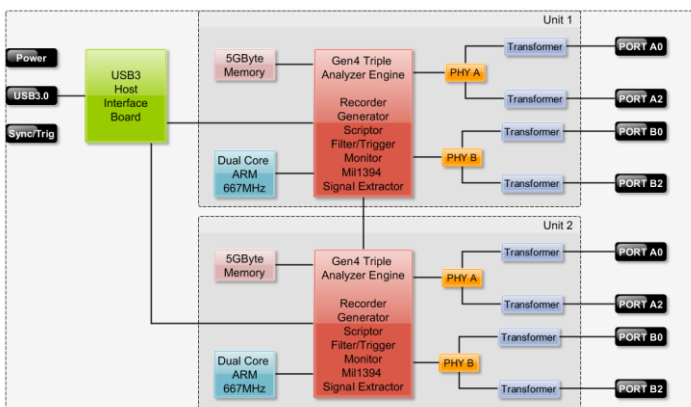

## A COMPLETE SOLUTION:

The **FireDiagnostics Suite** is the most comprehensive collection of 1394 analysis, simulation and interface tools for a wide range of applications. Apart from well-established and hardware assisted analyzer tools like Monitor, Recorder, Generator, Commander and Scriptor, the suite also offers a set of software tools designed to integrate the FireSpy products in a wide variety of testing applications, as well as extend customization of its functionality beyond the baseline feature set provided by DapTechnology.

The foundation for all software tools included in the FireDiagnostics Suite is formed by the **Application Programming Interface (API)**. With its interfaces for a wide range of development environments like C/C++ and support for the Windows operating system, the application of FireSpy analyzers is extremely flexible. With its feature-rich function library, all hardware assisted analyzer tools like the Recorder and Generator can be controlled as well as more low-level 1394 bus functions.

The **Recording Viewer** is a standalone application designed to permit trace (recorded data) analysis offline, i.e. without a connected FireSpy. The same comprehensive set of analysis tasks is available but allows for a much smaller PC footprint than having the entire FireSpy application installed.

The **Mil1394 Signal Monitor** is an easy-to-use Mil1394 sub-system monitor and analysis tool that benefits from the hardware-implemented Mil1394 protocol. A customizable set of status signals can be pulled from the bus and displayed in near real-time on a customizable graphical Control Panel. Alarms can be setup to alert the operator of out-of-range values.

Another cornerstone of the FireSpy products is the unparalleled high-level **protocol support**. Besides the hardware-assisted integration of Mil1394 the FireSpys also support software-based analysis capabilities for consumer and industrial control based applications. The different protocols require very different implementation details and are therefore very unique in their implementation. However, some key characteristics can be identified and are listed below:

- Nested protocol header decoding
- Protocol payload separation
- Handshake verification
- Logical grouping of related transactions
- Separate protocol view
- Protocol layer CRC and Parity Check
- Customization of display details

Additionally, separate applications (**Format Editor and Protocol Editor**) allow for the modification and extension of the factory default decoding and identification definitions. This extremely powerful and versatile tool enables experienced users to build on top of the standard definitions, engage in early prototyping and benchmarking of protocols still in the specification development process, as well as add proprietary extensions.

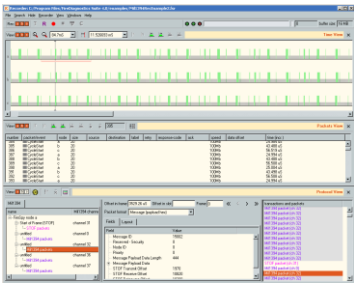

The **Recorder** is the main tool for data traffic capturing and analysis. Running all in HW/FW it guarantees precise time measurement, reliable data capture, instantaneous triggering and enough memory for even very complex analysis tasks. It contains several display views, which can all be switched on or off individually.

- Time View** - timing analysis of events and packets, resolution of 10 ns.
- Packet View** - chronological packet display with Trigger indicator and error verification
- Transaction View** - transaction-oriented display, verification of transaction completeness, transaction list or flow-diagram display
- Topology View** - static bus-topology display at the trace cursor position
- Protocol View** - high-level protocol analysis, encapsulated protocol verification, handshake verification, etc.

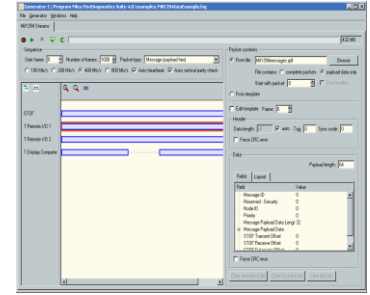

The **Generator** is optimized for the generation of isochronous stream data packets offering the most comprehensible feature set for the insertion of errors, streaming of simultaneous channels and payload definitions from stored files.

The **Stream Generator** includes a powerful graphical editor to specify slots with stream sequences to be sent for up to 63 channels. Each sequence consists of one or more stream packets with selectable data sources that can be fixed or from file. For each sequence one can select various options such as speed, packet size and header fields, including erroneous values. The overall sequence size is customizable in multiples of Cycle Periods. All Generator slots can be run in a looped-mode continuous transmission. Both the **Stream Generator** and the **Scriptor** can run in parallel for advanced isochronous and asynchronous combination testing.



Sophisticated protocol level support for the FireSpy is an essential component for supporting AS5643. Key features include:

- Generation** - STOF and stream generation, 1µs resolution
- Verification / Calculation** - Timing, Vertical Parity Check, Heartbeat
- Monitoring** - asynchronous stream payload field extraction

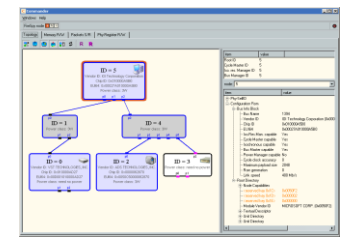
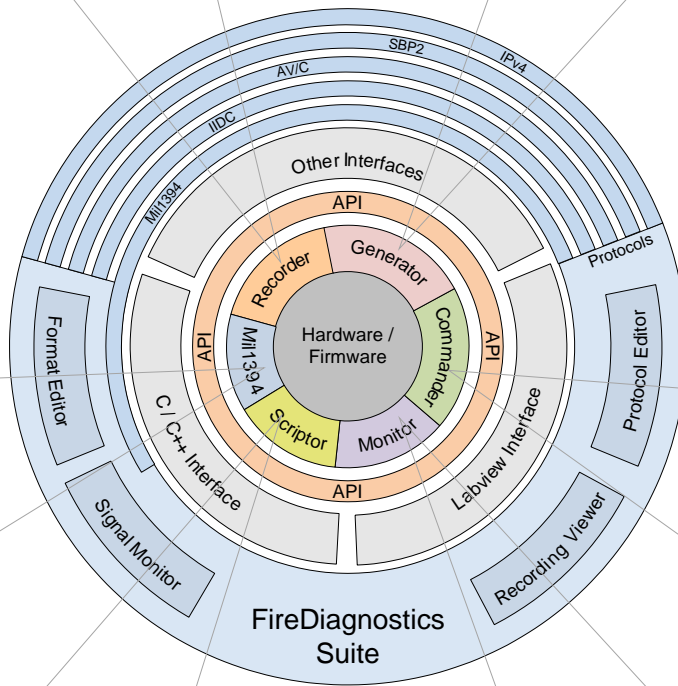

The **Commander** can be used to control the FireSpy functionality on a basic 1394 protocol level:

- Topology** - live display of the current bus topology, Configuration ROM Explorer
- Memory Read/Write** - R/W/L to memory locations of remote nodes,
- Packet S/R** - RX/TX of all packets, unformatted and erroneous packets.
- PHY Register** - R/W of PHY registers of the local and R of the remote nodes.

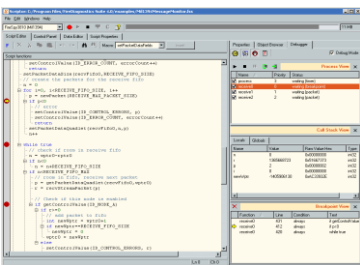

The **Scriptor** permits the definition of C-like scripts to control almost anything on the FireSpy, including sending and receiving packets. It is the preferred tool for the generation of individual asynchronous packets, asynchronous sequences and the simulation of entire handshakes.

- Script editor** - C-like script editor/compiler with automatic code block generation, integrated Debugger and floating-point data type support.
- Data editor** - defines data elements that can be used by the script, i.e. generation data.
- Control Panel** - display of values using different types of meters (gauge, LCD, thermometer, etc.).

The **Monitor** gives a quick indication of activities on the bus under test. The displayed data is updated in real time.

- Number of packets of specific types
- Number of packets of specific speeds
- Number of acknowledge packets
- Number of error packets
- Total number of packets
- Number of bus resets
- Bus voltage measurement

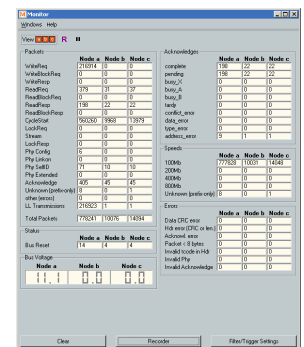

# MAIN FEATURE SUMMARY:

## GENERAL

- IEEE 1394-2008 Beta compliant
- Supports S100-S800 transfer rates depending on exact model
- Connects to host using USB3.0 interface
- 10GByte memory for embedded OS and packet and data storage
- Firmware field upgradeable to enable future expansions
- AUX connector for:
  - Trigger input and output functions
  - Recording external events
- GUI and API for Windows™ Operating Systems

## MONITOR

- Displays bus activity:
  - isochronous packets
  - all types of asynchronous packets
  - all types of PHY packets
  - all types of acknowledge packets
  - several types of Errors
- Counts packets according to type, speed, ack and error condition
- Counts number of bus resets

## RECORDER

- Time stamping of all packets and status events with 10ns resolution
- Packets hidden by slower connections are visible as 'prefix only' packets
- Extensive packet/event filtering/trigger/search capabilities
  - Packet type
  - Transmission speed
  - Boolean combination of 4 programmable packet sets
  - Data payload patterns
  - Error conditions
  - Various status events
  - Graphical Trigger Sequencer
- Adjustable trigger position within programmable record buffer size
- Cyclic pre-trigger buffer management option
- Different kinds of packet display views, including:
  - Time View, displays all packets on a time line, including the prefix
  - Packet View, displays packets as list plus selected packet options
  - Transaction View, displays transactions as list or flow graph
  - Topology View, graphical topology displays as is during recording
  - Protocol View, displays packets decoded to selected protocol
- Precise time measurements
- Marking of individual packets or packet ranges
- Export format for re-generation of packets by Scriptor or API

## GENERATOR

- Simultaneous generation of up to 63 iso streams on all buses
  - Graphically programming of stream transmit block
  - Data payload import from file
- Generator and Scriptor run simultaneous for stream and asynchronous packet generation
- Special Mil1394 stream generator package (optional)

## SCRIPTOR

- Script Editor
  - C-like scripting language
  - Function Library
  - Macros to automatically generate blocks of code
  - Syntax coloring
  - Integrated Debugger
  - Floating point data types
- Data Editor
- Control Panel
  - Graphical display elements for data value representation
  - Ethernet-connected Client Panels for remote data monitoring
- Several Sample Scripts

## COMMANDER

- Reading and/or writing of local and reading of remote PHY registers
- Reading and/or writing of remote memory locations (incl. CSR register space)
- Possibility to graphically view the current Topologies
- Sending of user definable packets

# SPECIFICATION:

<b>Dimensions:</b>	125 mm x 96 mm x 301 mm
<b>Weight:</b>	2090 g
<b>Operating Range:</b>	0 – 45°C
<b>Power Requirements:</b>	12V, 40 Watt maximum
<b>Compliance:</b>	FCC Class A
<b>Connections:</b>	USB 3.0 connector for host-computer 12x IEEE-1394 Bilingual connectors with screw holes for cable fixation
<b>Indicators:</b>	Red LEDs for: USB, Power  Multi-colored LEDs for: Unit status, Recorder, Scriptor, Generator, Active (per Node)
<b>Switches:</b>	Toggle switch for Power On/Off
<b>Package Content:</b>	FireSpy4x32bT Power Adapter (12V, 5A) USB 3.0 cable 4x LEMO to Bilingual cable
<b>Product warranty:</b>	36 months limited warranty
<b>Part Number:</b>	FS4432BT or FS4x32BTAS5643 (analyzer with SW protocol package)  FS4832BT or FS4832BTAS5643 (analyzer with SW protocol package)

FS 4 x 3 2 bT

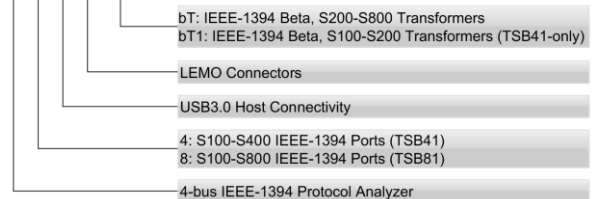

<b>SW Add-on modules:</b>	SBP2 protocol software package IIDC protocol software package AV/C protocol software package IP1394 protocol software package AS5643 protocol software package AMI-C protocol software package
---------------------------	---



## CONTACT INFORMATION:

[sales@daptechnology.com](mailto:sales@daptechnology.com)

[www.daptechnology.com](http://www.daptechnology.com)

**dap** TECHNOLOGY • **dap** USA •

DapTechnology B.V.  
Beatrixstraat 4  
7573AA Oldenzaal  
The Netherlands  
Ph: +31 243 556421

DapUSA, Inc.  
780 W San Angelo Street  
Gilbert, AZ 85233  
United States of America  
Ph: +1 480 422 1551